

MAINTENANCE REMINDER SHEET

X300 with 38" Edge Deck

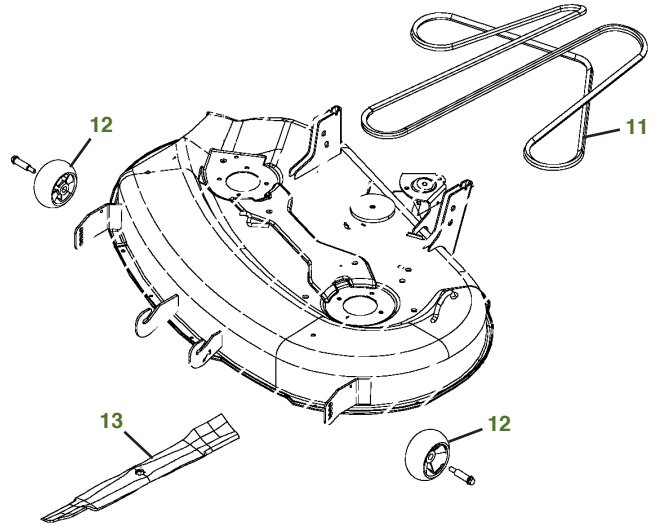
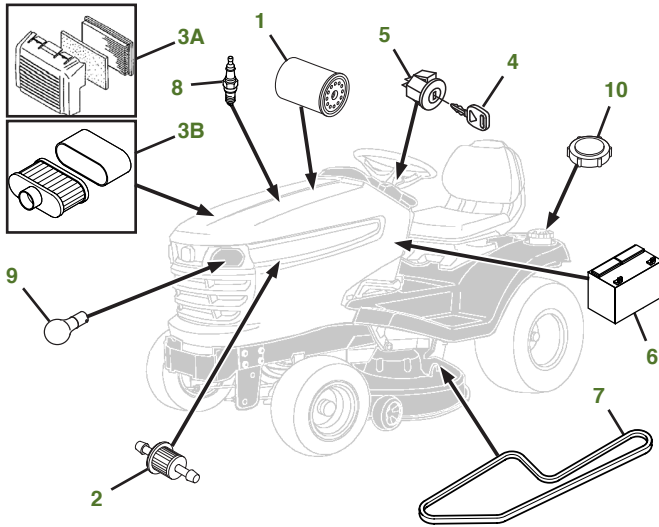

Tractor S/N

Deck S/N

Key	Part No.	Description	Key	Part No.	Description
1	AM107423	ENGINE OIL FILTER-ENG FH491V	7	M144044	BELT-TRACTION DRIVE
	AM125424	ENGINE OIL FILTER-ENG FS541V	8	TY6081	SPARK PLUG-ENG FH491V
2	AM116304	FUEL FILTER-IN-LINE		M805853	SPARK PLUG-ENG FS541V
3A	MIU10999	AIR FILTER-FOAM-ENG FH491V	9	AD2062R	HEADLIGHT BULB
	MIU10998	AIR FILTER-PAPER-ENG FH491V	10	AM137724	FUEL CAP-ENG FH491V
3B	MIU12554	AIR FILTER-FOAM-ENG FS541V		AM141406	FUEL CAP-ENG FS541V
	MIU12555	AIR FILTER-PAPER-ENG FS541V	11	M154601	BELT-MOWER (W/ BELT TENS)
4	CY20680	KEY		M155525	BELT-MOWER (W/O BELT TENS)
5	AM133596	IGNITION SWITCH (S/N -040000)	12	M111489	GAGE WHEEL
	AM133597	IGNITION SWITCH (S/N 040001-)	13	AM141039	KIT-SIDE DISCHARGE 38"
6	TY25878	BATTERY (S/N -250000)		AM141041	KIT-BAGGING 38"
	TY25221	BATTERY (S/N 250001-)		AM141040	KIT-MULCHING 38"

Parts Needed in First 250 Hours of Operation

Qty	Part No	Item	Qty or Capacity	Change Interval In Hours
6	TY22029	1 qt Engine Oil Turf-Gard™ 10W30	1.8 qt	8/100/200
3	AM107423 or AM125424	Engine Oil Filter	1	8/100/200
2	MIU10999 or MIU12554	Air Filter-Foam	1	100/200
2	MIU10998 or MIU12555	Air Filter-Paper	1	100/200
2	AM116304	Fuel Filter-In-Line	1	100/200
4	TY6081 or M805853	Spark Plug	2	100/200
2	TY6341	JD Multi Purpose SD Polyurea Grease		As Needed

"As Needed" Parts

Qty	Part No	Item
1	AM130907	Mower Deck Leveling Gauge
1	TY26518	Grease Gun

Home Maintenance Kit

Unit	Kit Number
X300	LG256 (Eng FH491V) LG265 (Eng FS541V)

CLICK PART NUMBER TO BUY