

REPLACEMENT PARTS GUIDE

CS770 Cotton Stripper (S.N. 249000 -)

CAB

FRESH AIR FILTER

[RE284091](#)

Clean or replace every 50 hours or as required. If operating in dusty conditions clean daily.

RECIRCULATION AIR FILTER

[AXE70605](#)

Clean or replace every 250 hours or as required. If operating in dusty conditions clean daily.

ENIGNE

DIESEL EXHAUST FLUID DOSING FILTER

[DZ114640](#)

Replace after first 1500 hours or 3 years, whichever occurs first.

FUEL PRECLEANER FILTER

[R502778](#)

Replace every 400 hours or annually, whichever occurs first.

DEF BREATHER

[H216169](#)

Replace every 2000 hours.

PRIMARY AIR FILTER

[HXE11090](#)

Replace every 400 hours or annually, whichever occurs first.

SECONDARY AIR FILTER

[HXE11091](#)

Replace every 400 hours or annually, whichever occurs first.

FUEL FILTER

[AN278127](#)

[AT365869](#)

[DZ124760](#)

Replace every 400 hours or annually, whichever occurs first.

ENIGNE

OIL FILTER

[RE572785](#)

Minimum hours before first engine oil change is 100 hours. Extended engine oil change every 375 hours or annually, whichever come first. The extended 375 hour interval is only allowed if using Plus-50™ II oil with a John Deere filter and diesel fuel with sulfur content less than 15mg/kg (15ppm). If all conditions are not met, change oil and filter at 250 hours of operation.

PRIMARY FUEL FILTER

[DZ124761](#)

Replace every 400 hours or annually, whichever occurs first.

SECONDARY FUEL FILTER

[DZ124786](#)

Replace every 400 hours or annually, whichever occurs first.

HYDRAULICS

CHASSIS RETURN OIL FILTER

[AKK33523](#)

Replace every 1000 hours.

PUMP FILTER

[AKK43338](#)

Replace every 1000 hours.

BALER DRIVE PUMP OIL FILTER

[AKK42419](#)

Replace every 1000 hours.

ENIGNE

DIESEL EXHAUST FLUID IN-LINE FILTER

[DZ110513](#)

Replace after first 1500 hours or 3 years, whichever occurs first.

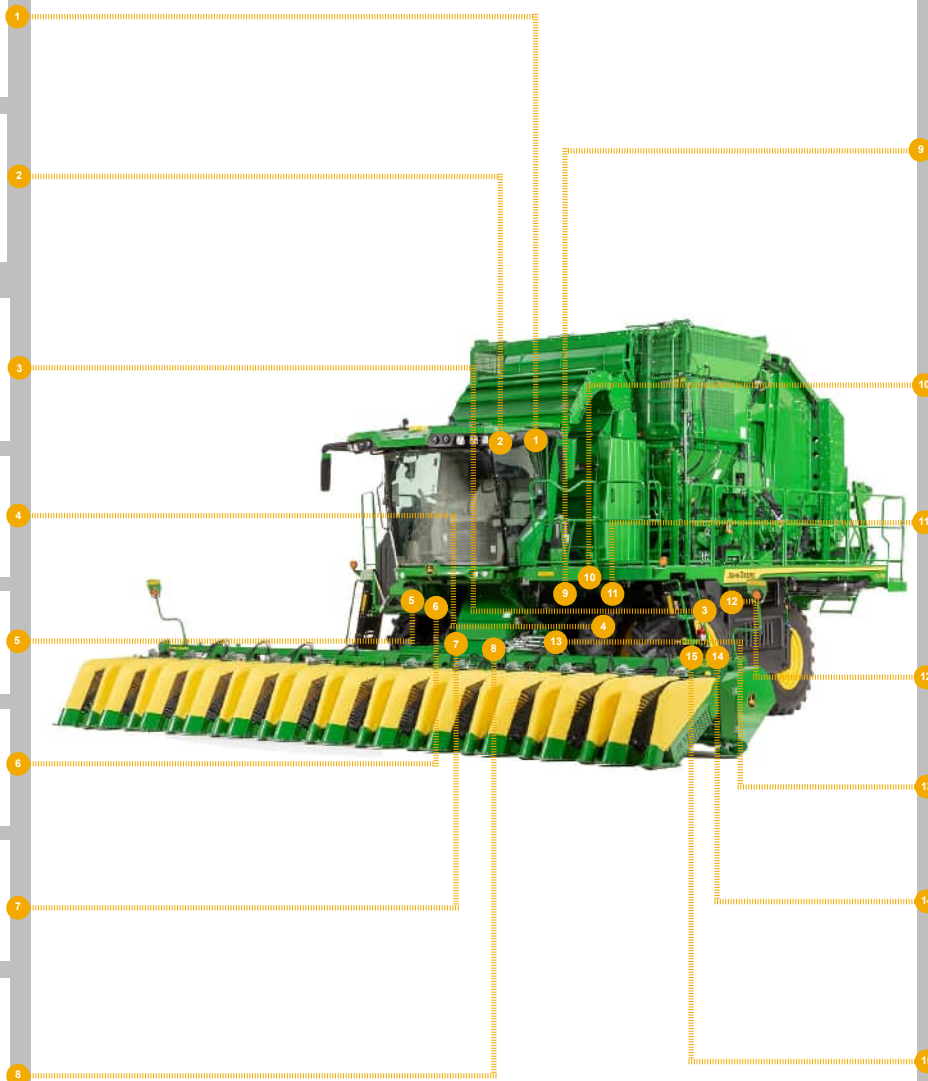

CAPACITIES

CS770 Cotton Stripper (S.N. 249000 -)

CAPACITIES (Approximate):

Fuel Tank:

..... 1022 L (270 gal)

Diesel Exhaust Fluid Tank:

John Deere Diesel Exhaust Fluid™

(Final Tier 4/Stage IV and Stage V only):

..... 104.4 L (27.5 gal)

Auxiliary Water Tank:

John Deere Spindle Cleaner™

..... 257 L (68 gal)

Cooling System:

Cool-Gard™ II

Final Tier 4/Stage IV and Stage V 68.1 L (18 gal)

Engine Crankcase (Includes Filter):

Plus-50™ II

Final Tier 4/Stage IV and Stage V 56.7 L (15 gal)

Hydraulic Oil Reservoir:

Hy-Gard™

..... 113.5 L (30 gal)

Hydraulic and Hydrostatic System:

Hy-Gard™

..... 216 L (57 gal)

Final Drive: (2 Used)

GL-5

Standard Capacity 7.8 L (2 gal)

High Capacity 23 L (6.1 gal)

Row Unit Gear Case: (6 Used)

Hy-Gard™

..... 25 L (6.6 gal)

Rear Axle Main Body Housing:

GL-5

..... 9.9 L (2.6 gal)

Rear Axle Auxiliary Gearbox:

GL-5

..... 1.3 L (0.34 gal)

Rear Axle Planetary: (2 Used)

GL-5

..... 3.8 L (1 gal)

REPLACEMENT PARTS GUIDE

CS770 Cotton Stripper (S.N. 249000 -)

- 

SPRING TENSION FEEDER BELT
[AKK32901](#)
 Prevents belt slippage, easier to set tension.
- 

CLEANER & FEEDER PADDLE
[AKK36512](#)
- 

CLEANER & FEEDER AUGER
[AKK43730](#)
- 

CLEANER DOFFER ASSEMBLY
[AKK23874](#)
- 

CLEANER DOFFER BRUSH
[AKK23868](#)
- 

CLEANER SAW ASSEMBLY
[AKK51674](#)
- 

CLEANER SAW SEGMENTS
[N221590](#)
- 

CLEANER SAW BEARINGS
[AN220646](#)
- 

SPHERICAL BALL BEARING
[JD8673](#)





- 

ROLLER BRUSH
[KK72056](#)
- 

ROUND MODULE BELT PIN
[KK36931](#)
- 

ROUND MODULE BELTS
[AKK29500](#)
[AKK29499](#)
- 

GROOVED WRAP ROLLER
[AKK22228](#)
 Reduce wrap misfeeds caused by wrapping rear roller.
- 





CLEANER DRIVE V BELT
[N117398](#)
[N33746](#)
[M91270](#)
- 

CYLINDRICAL BALL BEARING
[AN272787](#)





REPLACEMENT PARTS GUIDE

CS770 Cotton Stripper (S.N. 249000 -)

ROUND MODULE BUILDER (RMB)





-  **ROUND MODULE BELT PIN**
[KK36931](#)
-  **ROUND MODULE BELTS**
[AKK29500](#)
[AKK29499](#)
-  **SPRING TENSION FEEDER BELT**
[AKK32901](#)
-  **WRAP FLOOR FINGER**
[KK80970](#)

STRIPPER HEADER



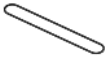

-  **LH AND RH RETAINER**
[N125408](#)
-  **AUGER**
[AN221692](#) (RH)
[AN221693](#) (LH)
-  **CROP GUIDES SUPPORT**
[AKK26977](#) (RH)
[AKK26976](#) (LH)
-  **CROP GUIDES SHOE**
[N220836](#) (RH)
[N220837](#) (LH)



ROUND MODULE BUILDER (RMB)

-  **ROLLER BRUSH RETAINER**
[KK83562](#)
-  **ROLLER BRUSH**
[KK72056](#)
-  **RMB WRAP FLOOR BELT**
[M91270](#)
-  **WRAP ROLLER DRIVE CHAIN**
[AKK46608](#)

STRIPPER HEADER

-  **CROP GUIDES STRAP**
[N220186](#)
-  **SECTION V BELT**
[KK66252](#)
-  **HEIGHT SENSING ROD**
[N223457](#)
-  **CROP GUIDES BAR**
[N221256](#) (RH)
[N221257](#) (LH)
-  **LH AND RH BAT/FLAP**
[AN123821](#)