

# FILTER OVERVIEW WITH SERVICE INTERVALS AND CAPACITIES

## 9650 STS, 9750 STS Series Combines

### ENGINE AIR FILTER

SECONDARY AIR FILTER (9650) – [RE63932](#)

SECONDARY AIR FILTER, HIGH CAPACITY (9650-9750) – [AH164063](#)

Change secondary filter only with primary filter.

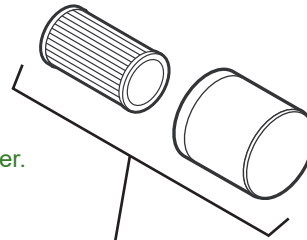

### ENGINE AIR FILTER

PRIMARY AIR FILTER (9650) – [AH148880](#)

PRIMARY AIR FILTER, HIGH CAPACITY (9650-9750) – [AH164062](#)

Replace every 400 hours or service filters only when engine air filter light stays ON or change as required.

Note: Replace secondary filter with primary filter.

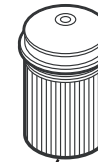

### ENGINE OIL FILTER

OIL FILTER (9650-9750) – [RE57394](#)

For Engine 6081HH005, 6081HH006 Up To Engine Serial Number ( -199999).

OIL FILTER (9650-9750) – [RE509672](#)

For Engine 6081HH012, 6081HH013 From Engine Serial Number (200000 - ).

Replace after first 100 hours and then every 250 hours. Fill Crankcase with seasonal viscosity grade oil or Torq-Gard™ Supreme (250 hours change interval). Change oil every 500 hours when using John Deere Plus-50™ II engine oil and a John Deere filter.

Note : Change oil every 100 hours if fuel contains more than 0.5 % sulfur.

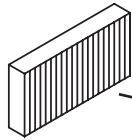

### CAB AIR FILTER

RECIRCULATION AIR FILTER – [AH115836](#)

Clean or replace every 200 hours and as required.

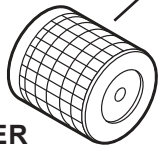
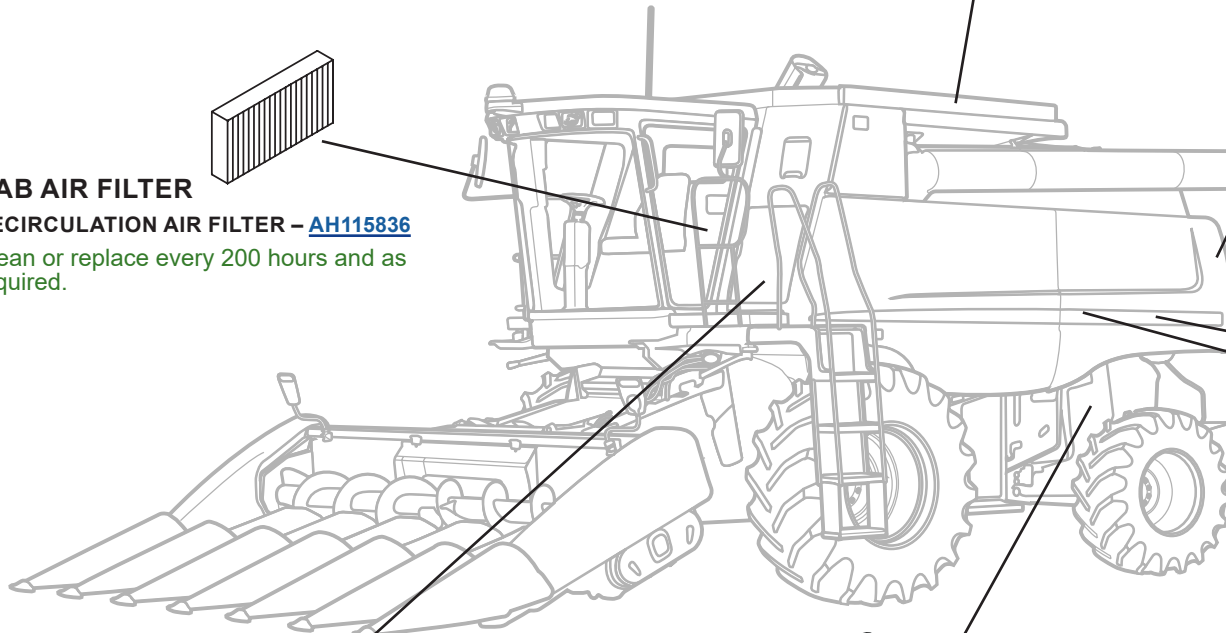

### CAB AIR FILTER

AIR FILTER, HEAVY DUTY – [AH168783](#)

AIR FILTER, STANDARD – [AH115833](#)

Clean or replace after 50 hours and as required.

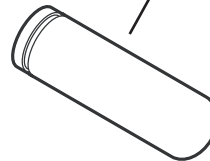

### HYDROSTATIC PUMP / ENGINE GEARCASE / HYDRAULIC FILTER

OIL FILTER – [AH128449](#)

Replace every 400 hours.

Note: Replace all three filters at a time.

### ENGINE FUEL FILTER

FUEL FILTER – [AR86745](#)

For Engine 6081HH005, 6081HH006 Up To Engine Serial Number ( -199999).

FUEL FILTER – [RE522372](#)

For Engine 6081HH012, 6081HH013 From Engine Serial Number (200000 - ).

PRIMARY FUEL FILTER – [RE531703](#)

For Engine 6081HH012 From Engine Serial Number (232463- ).

PRIMARY FUEL FILTER – [R502778](#)

For Engine 6081HH012 Up To Engine Serial Number ( -232462).

For Engine 6081HH013 From Engine Serial Number (200000 - ).

SECONDARY FUEL FILTER – [RE522688](#)

For Engine 6081HH012 From Engine Serial Number (232463- ).

For Engine 6081HH013 From Engine Serial Number (200000 - ).

SECONDARY FUEL FILTER – [RE522372](#)

For Engine 6081HH012 Up To Engine Serial Number ( -232462).

For Engine 6081HH013 From Engine Serial Number (200000 - ).

SECONDARY FUEL FILTER – [RE522687](#)

For Engine 6081HH013 From Engine Serial Number (200000 - ).

FUEL WATER SEPARATOR FILTER – [RE500186](#)

For 9650 ( -695500) and For 9750 ( -695600).

Replace every 500 hours.

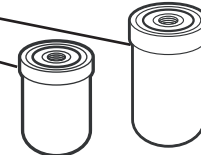

(Click here for [capacity](#))



**JOHN DEERE**

Genuine Parts and Service

# CAPACITIES

## 9650 STS, 9750 STS Series Combines

### CAPACITIES (Approximate):

#### Fuel Tank:

9650 ( -695500), 9750 ( -695600) .....	757 L (199.97 gal)
9650 (695501- ), 9750 (695601- ) .....	945 L (249.64 gal)

#### Cooling System with Heater:

##### Cool-Gard™

9650 ( -695500), 9750 ( -695600) .....	38 L (10.03 gal)
--	------------------

#### Cooling System without Heater:

##### Cool-Gard™

9650 ( -695500), 9750 ( -695600) .....	45 L (11.88 gal)
--	------------------

#### Hydraulic / Hydrostatic Reservoir:

##### Low Viscosity Hy-Gard™

9650, 9750 .....	34 L (8.98 gal)
------------------	-----------------

#### Feeder House Reverser Gearcase:

##### GL-5

Standard (9650, 9750) .....	0.9 L (0.23 gal)
High Capacity without Cooler (9650, 9750) .....	1.8 L (0.47 gal)
High Capacity with Cooler (9650, 9750) .....	3.5 L (0.92 gal)

#### Final Drives (each):

##### GL-5

9650, 9750 .....	8.5 L (2.24 gal)
------------------	------------------

#### Countershaft Drive Gearcase:

##### GL-5

9650, 9750 .....	1.2 L (0.31 gal)
------------------	------------------

#### Loading Auger Gearcase:

##### GL-5

9650, 9750 .....	3.8 L (1 gal)
------------------	---------------

#### Engine Gearcase with Transfer:

##### Low Viscosity Hy-Gard™

9650, 9750 .....	21.3 L (5.62 gal)
------------------	-------------------

#### Engine Crankcase with Filter:

##### Torq-Gard Supreme™ or Plus-50™ II

9650, 9750 .....	28.5 L (7.52 gal)
------------------	-------------------

#### Transmission:

##### GL-5

9650, 9750 .....	9.6 L (2.53 gal)
------------------	------------------

#### Two Speed Separator Drive Gearcase:

##### GL-5

9650, 9750 .....	4.7 L (1.24 gal)
------------------	------------------

[Return to Filter Overview](#)

