

# MAINTENANCE REMINDER SHEET

## X380 with 48" Accel Deep™ Deck

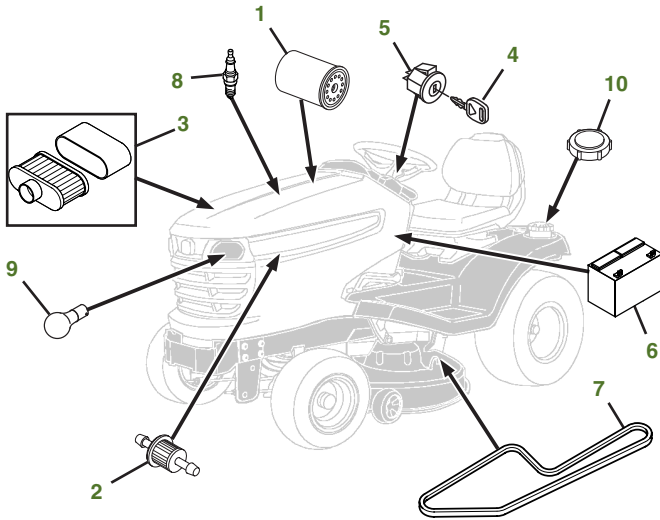

Tractor S/N

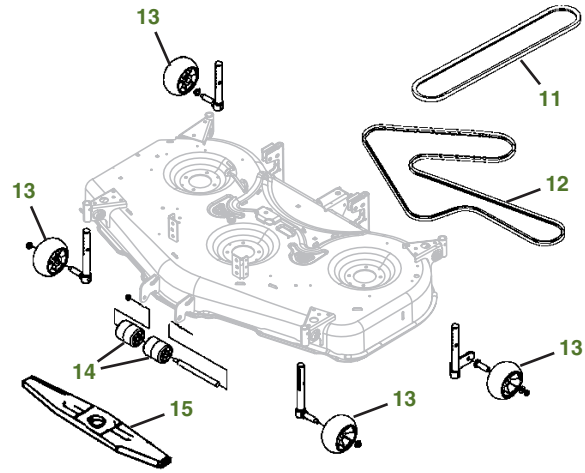

Deck S/N

Key	Part No.	Description	Key	Part No.	Description
1	<a href="#">AM125424</a>	ENGINE OIL FILTER	7	<a href="#">M144044</a>	BELT-TRACTION DRIVE
2	<a href="#">AM116304</a>	FUEL FILTER-IN-LINE	8	<a href="#">M805853</a>	SPARK PLUG
3	<a href="#">MIU12554</a>	AIR FILTER-FOAM	9	<a href="#">AD2062R</a>	HEADLIGHT BULB
	<a href="#">MIU12555</a>	AIR FILTER-PAPER	10	<a href="#">AM141406</a>	FUEL CAP
4	<a href="#">GY20680</a>	KEY	11	<a href="#">M169485</a>	BELT-MOWER-PRIMARY
5	<a href="#">AM133597</a>	IGNITION SWITCH	12	<a href="#">M169500</a>	BELT-MOWER-SECONDARY
6	<a href="#">TY25221</a>	BATTERY	13	<a href="#">M111489</a>	GAGE WHEEL
			14	<a href="#">M113955</a>	FRONT ROLLER
			15	<a href="#">M145476</a>	BLADE-SIDE DISCHARGE 48"
				<a href="#">M127673</a>	BLADE-MULCHING 48"
				<a href="#">BM24993</a>	MulchControl™ KIT

### Parts Needed in First 250 Hours of Operation

Qty	Part No	Item	Qty or Capacity	Change Interval In Hours
5	<a href="#">TY22029</a>	Engine Oil Turf-Gard™ 10W30	2.1 L (2.2 qt)	100/200
2	<a href="#">AM125424</a>	Engine Oil Filter	1	100/200
2	<a href="#">MIU12554</a>	Air Filter-Foam	1	100/200
2	<a href="#">MIU12555</a>	Air Filter-Paper	1	100/200
2	<a href="#">AM116304</a>	Fuel Filter-In-Line	1	100/200
4	<a href="#">M805853</a>	Spark Plug	2	100/200
2	<a href="#">TY24416</a>	John Deere Multi-Purpose HD Lithium Complex Grease		As Needed

### "As Needed" Parts

Qty	Part No	Item
1	<a href="#">AM130907</a>	Mower Deck Leveling Gauge
1	<a href="#">TY26518</a>	Grease Gun

### Home Maintenance Kit

Unit	Kit Number
X350	<a href="#">LG265</a>

CLICK PART NUMBER TO BUY