

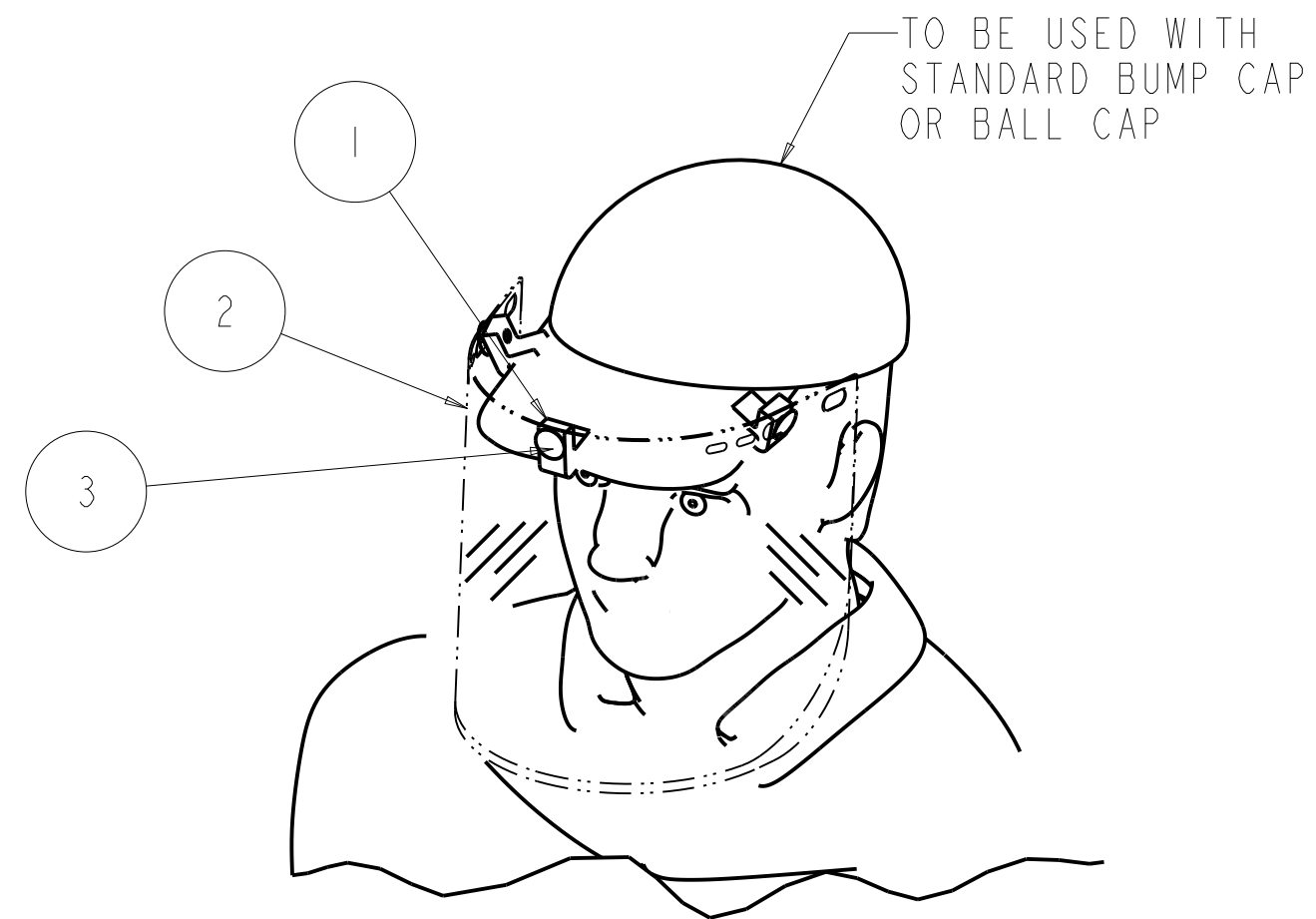

REV	DETAIL	SHEET	DESCRIPTION	QTY	APPROXIMATE STOCK SIZE / SPEC.	MATERIAL	HARD	PUR
	1	3	3D PRINTED CLIP	3	.63 X 1.13 X 1.25	ASA OR PLA		3DP
*	2	1	FACE SHIELD	1	#K8154PC (IM3001928705)	MAGID		X
	3	1	PLASTIC RETAINER	3	#15414 (100 PCS)	AUVECO		X

*MAY BE SUBSTITUTED FOR JACKSON BRAND PN: 29104
8 x 15.5 x .040 CLEAR PETG (1 = 100 PCS)

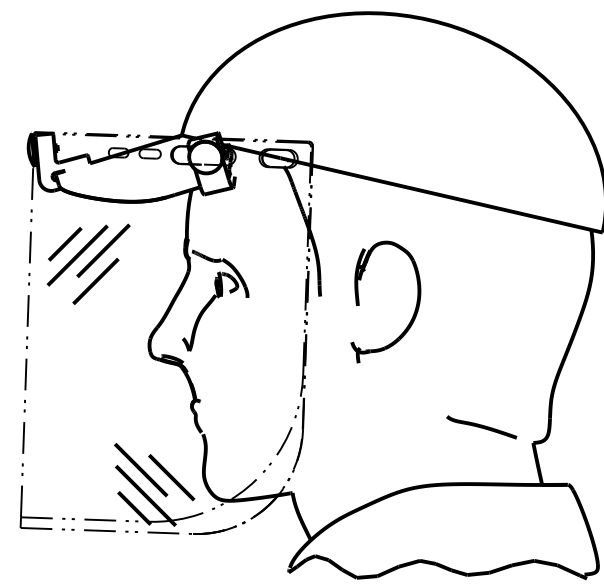
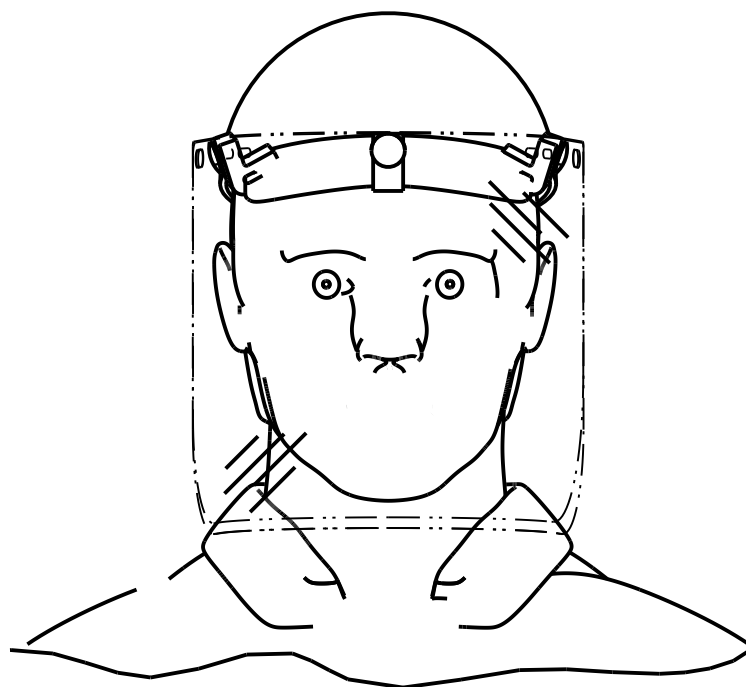
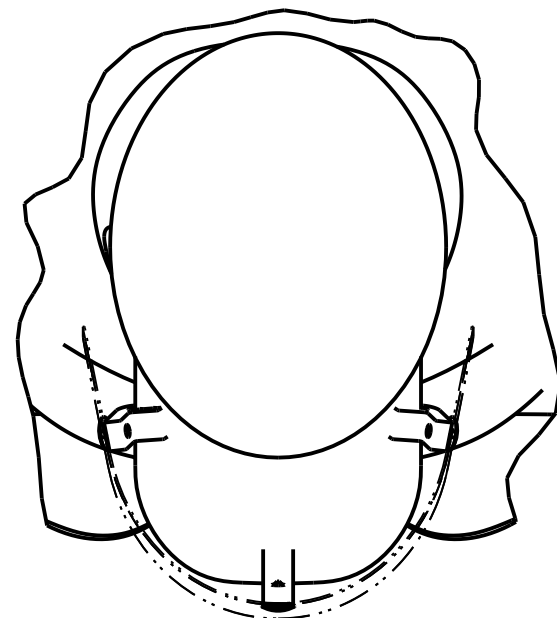

John Deere 3D-Printed Face Shield Clips Design

Deere & Company is publishing these part files, drawings, and other supporting documentation (the "Clip Design") to the community as a free service in response to the global COVID 19 pandemic, and subject to the following conditions.

WARNING AND DISCLAIMER:

DEERE IS MAKING THE CLIP DESIGN AVAILABLE "AS IS" AND FOR USE AT YOUR OWN RISK, AND WITHOUT ANY REPRESENTATIONS, GUARANTEES, OR WARRANTIES OF ANY KIND, EXPRESS OR IMPLIED, AND SPECIFICALLY WITHOUT LIMITATION ANY WARRANTIES OF NON-INFRINGEMENT OR FITNESS FOR A PARTICULAR PURPOSE. SPECIFICALLY, THE CLIP DESIGN IS BEING PROVIDED WITHOUT ANY REPRESENTATION THAT THE CLIP DESIGN AND ITEMS DESCRIBED THEREIN ARE, HAVE BEEN EVALUATED, OR ARE APPROVED UNDER ANY FEDERAL OR STATE REGULATION FOR THE TREATMENT, PROTECTION FROM, OR PREVENTION OF ANY SPECIFIC HEALTH PROBLEMS, DISEASES, OR INFECTIONS, INCLUDING COVID-19. USERS OF THE CLIP DESIGN AND ITEMS DESCRIBED THEREIN ARE RESPONSIBLE FOR DETERMINING THE APPROPRIATE CIRCUMSTANCES, IF ANY, FOR THEIR USE OR FOR PROVIDING THEM TO OTHERS FOR USE. IN NO EVENT SHALL DEERE BE LIABLE FOR ANY DIRECT, INDIRECT, INCIDENTAL, SPECIAL, EXEMPLARY, OR CONSEQUENTIAL DAMAGES HOWEVER CAUSED AND ON ANY THEORY OF LIABILITY, WHETHER IN CONTRACT, STRICT LIABILITY, OR TORT (INCLUDING NEGLIGENCE OR OTHERWISE) ARISING IN ANY WAY OUT OF THE USE OF THE CLIP DESIGN, EVEN IF ADVISED OF THE POSSIBILITY OF SUCH DAMAGE. YOU SHALL HOLD HARMLESS AND INDEMNIFY DEERE AGAINST ANY AND ALL CLAIMS BROUGHT AGAINST DEERE ARISING FROM YOUR USE OF THE CLIP DESIGN AND ITEMS DESCRIBED THEREIN.

IP LICENSE: DEERE HEREBY GRANTS A LIMITED NON-EXCLUSIVE ROYALTY-FREE LICENSE TO INDIVIDUALS OR ORGANIZATIONS USING THE CLIP DESIGN TO AID IN THE RESPONSE TO COVID-19. THIS LICENSE DOES NOT INCLUDE ANY RIGHT TO USE ANY DEERE TRADEMARKS. DEERE RETAINS ALL RIGHTS AND PRIVILEGES AND MAY RETRACT THIS LIMITED NON-EXCLUSIVE LICENSE AT ANY TIME AND AT DEERE'S SOLE DISCRETION.

IMPORTANT SAFETY INFORMATION:

- NOT FOR PREVENTION OF DISEASE: The face shield clips are not intended to treat, protect from or prevent specific health problems, diseases, or infections, including respiratory diseases such as COVID 19.
- SINGLE-USE ONLY: The face shield clips are for single use only as they have not been designed to permit disinfection after initial use.
- INTENDED FOR KNOWLEDGEABLE USERS: Individuals or organizations that receive the face shield clips are responsible for using them in the appropriate circumstances, including satisfying any federal or state regulatory requirements that apply to medical selection and use of face shields or face shield clips, and are responsible for informing health care providers to which the clips are supplied that they are responsible for decisions regarding appropriate personal protective equipment for their personnel.

By downloading, copying, or using the Clip Design, you acknowledge and agree to these terms.

Deere & Company
April 2020

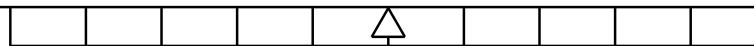
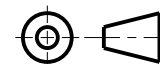

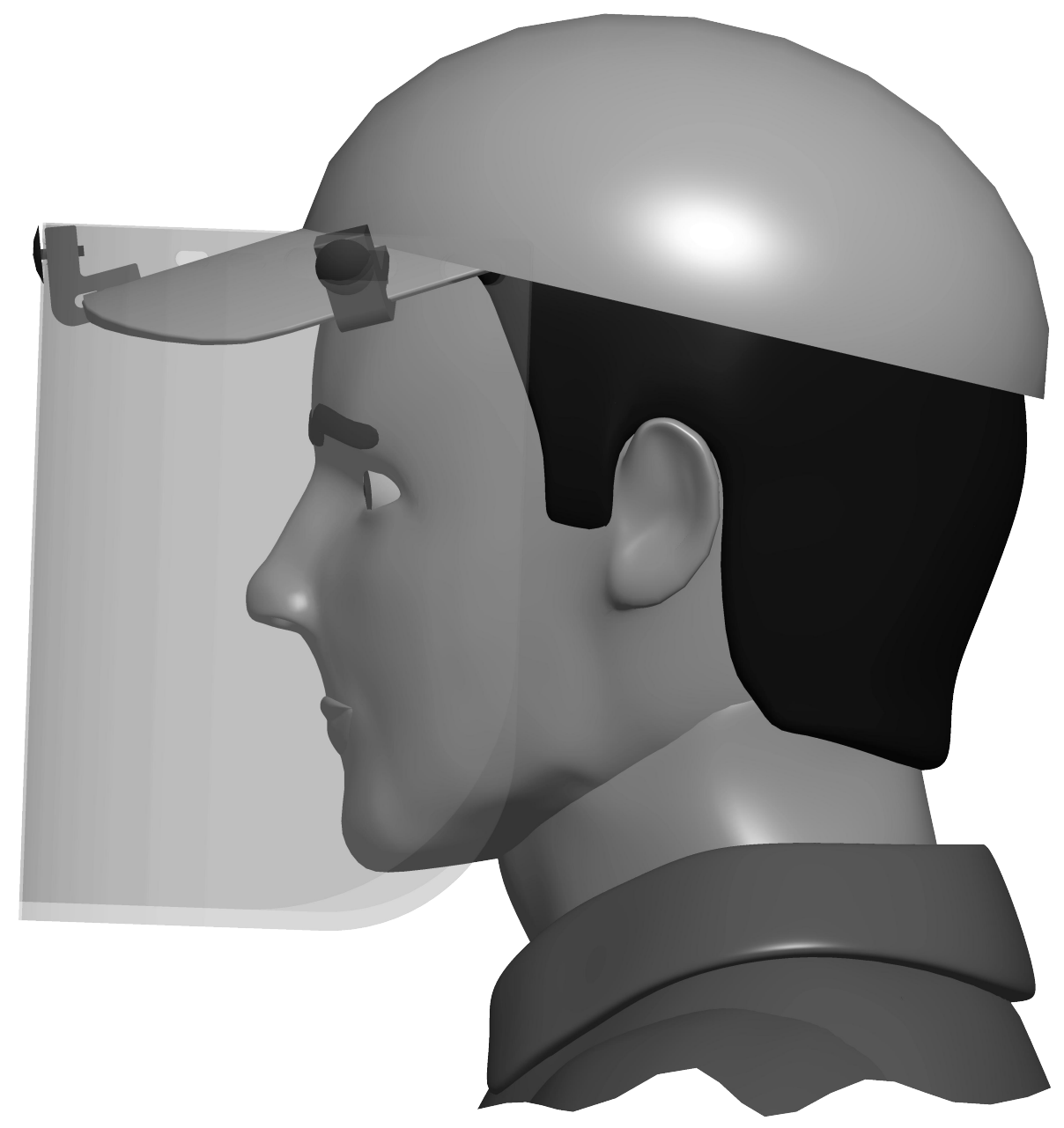
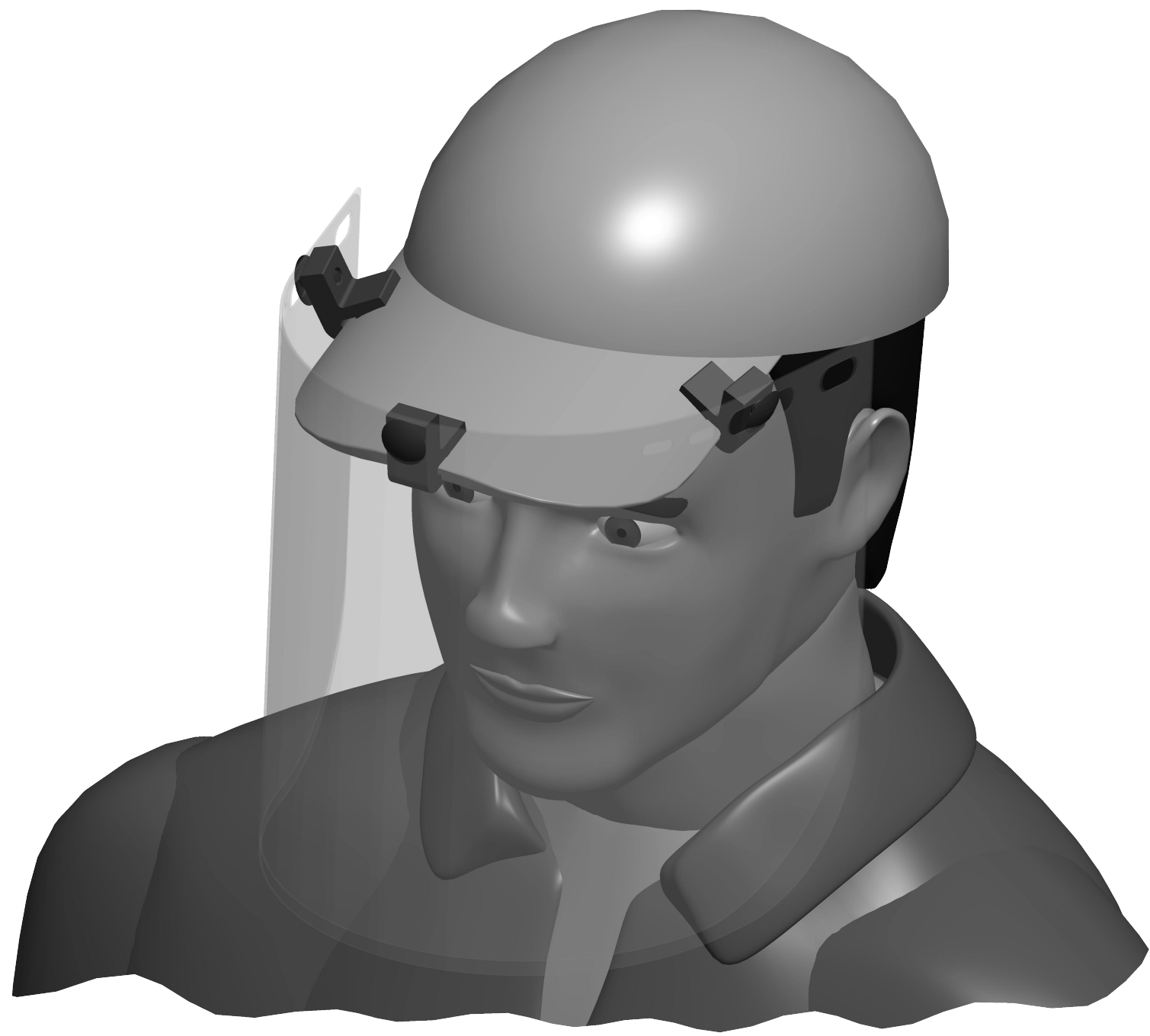

John Deere 3D-Printed Face Shield Clips Design

Deere & Company is publishing these part files, drawings, and other supporting documentation (the "Clip Design") to the community as a free service in response to the global COVID 19 pandemic, and subject to the following conditions.

WARNING AND DISCLAIMER:

DEERE IS MAKING THE CLIP DESIGN AVAILABLE "AS IS" AND FOR USE AT YOUR OWN RISK, AND WITHOUT ANY REPRESENTATIONS, GUARANTEES, OR WARRANTIES OF ANY KIND, EXPRESS OR IMPLIED, AND SPECIFICALLY WITHOUT LIMITATION ANY WARRANTIES OF NON-INFRINGEMENT OR FITNESS FOR A PARTICULAR PURPOSE. SPECIFICALLY, THE CLIP DESIGN IS BEING PROVIDED WITHOUT ANY REPRESENTATION THAT THE CLIP DESIGN AND ITEMS DESCRIBED THEREIN ARE, HAVE BEEN EVALUATED, OR ARE APPROVED UNDER ANY FEDERAL OR STATE REGULATION FOR THE TREATMENT, PROTECTION FROM, OR PREVENTION OF ANY SPECIFIC HEALTH PROBLEMS, DISEASES, OR INFECTIONS, INCLUDING COVID-19. USERS OF THE CLIP DESIGN AND ITEMS DESCRIBED THEREIN ARE RESPONSIBLE FOR DETERMINING THE APPROPRIATE CIRCUMSTANCES, IF ANY, FOR THEIR USE OR FOR PROVIDING THEM TO OTHERS FOR USE. IN NO EVENT SHALL DEERE BE LIABLE FOR ANY DIRECT, INDIRECT, INCIDENTAL, SPECIAL, EXEMPLARY, OR CONSEQUENTIAL DAMAGES HOWEVER CAUSED AND ON ANY THEORY OF LIABILITY, WHETHER IN CONTRACT, STRICT LIABILITY, OR TORT (INCLUDING NEGLIGENCE OR OTHERWISE) ARISING IN ANY WAY OUT OF THE USE OF THE CLIP DESIGN, EVEN IF ADVISED OF THE POSSIBILITY OF SUCH DAMAGE. YOU SHALL HOLD HARMLESS AND INDEMNIFY DEERE AGAINST ANY AND ALL CLAIMS BROUGHT AGAINST DEERE ARISING FROM YOUR USE OF THE CLIP DESIGN AND ITEMS DESCRIBED THEREIN.

IP LICENSE: DEERE HEREBY GRANTS A LIMITED NON-EXCLUSIVE ROYALTY-FREE LICENSE TO INDIVIDUALS OR ORGANIZATIONS USING THE CLIP DESIGN TO AID IN THE RESPONSE TO COVID-19. THIS LICENSE DOES NOT INCLUDE ANY RIGHT TO USE ANY DEERE TRADEMARKS. DEERE RETAINS ALL RIGHTS AND PRIVILEGES AND MAY RETRACT THIS LIMITED NON-EXCLUSIVE LICENSE AT ANY TIME AND AT DEERE'S SOLE DISCRETION.

IMPORTANT SAFETY INFORMATION:

- NOT FOR PREVENTION OF DISEASE: The face shield clips are not intended to treat, protect from or prevent specific health problems, diseases, or infections, including respiratory diseases such as COVID 19.
- SINGLE-USE ONLY: The face shield clips are for single use only as they have not been designed to permit disinfection after initial use.
- INTENDED FOR KNOWLEDGEABLE USERS: Individuals or organizations that receive the face shield clips are responsible for using them in the appropriate circumstances, including satisfying any federal or state regulatory requirements that apply to medical selection and use of face shields or face shield clips, and are responsible for informing health care providers to which the clips are supplied that they are responsible for decisions regarding appropriate personal protective equipment for their personnel.

By downloading, copying, or using the Clip Design, you acknowledge and agree to these terms.

Deere & Company
April 2020

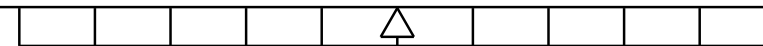
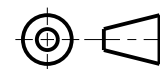



DETAIL DESIGNED FOR 3D PRINTING

REV	DETAIL	SHEET	DESCRIPTION	QTY	APPROXIMATE STOCK SIZE / SPEC.	MATERIAL	HARD	PUR
	1	3	3D PRINTED CLIP	3	.63 X 1.13 X 1.25	ASA OR PLA		3DP

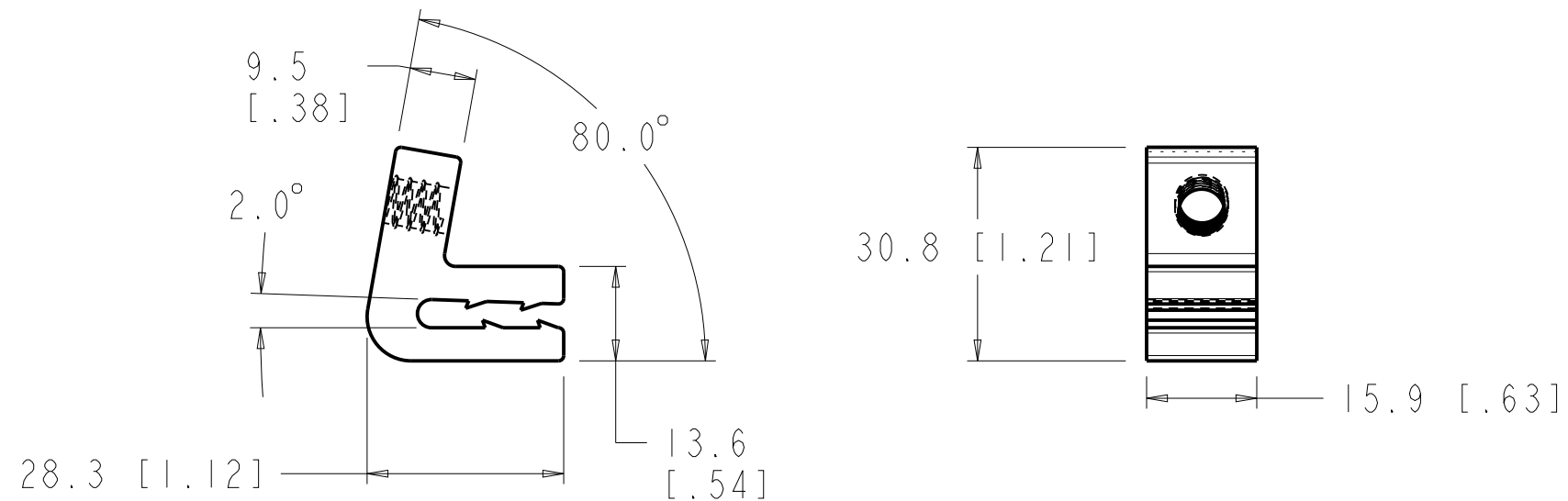
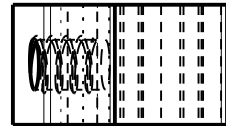

3D PRINT PER CAD GEOMETRY

John Deere 3D-Printed Face Shield Clips Design

Deere & Company is publishing these part files, drawings, and other supporting documentation (the "Clip Design") to the community as a free service in response to the global COVID 19 pandemic, and subject to the following conditions.

WARNING AND DISCLAIMER:

DEERE IS MAKING THE CLIP DESIGN AVAILABLE "AS IS" AND FOR USE AT YOUR OWN RISK, AND WITHOUT ANY REPRESENTATIONS, GUARANTEES, OR WARRANTIES OF ANY KIND, EXPRESS OR IMPLIED, AND SPECIFICALLY WITHOUT LIMITATION ANY WARRANTIES OF NON-INFRINGEMENT OR FITNESS FOR A PARTICULAR PURPOSE. SPECIFICALLY, THE CLIP DESIGN IS BEING PROVIDED WITHOUT ANY REPRESENTATION THAT THE CLIP DESIGN AND ITEMS DESCRIBED THEREIN ARE, HAVE BEEN EVALUATED, OR ARE APPROVED UNDER ANY FEDERAL OR STATE REGULATION FOR THE TREATMENT, PROTECTION FROM, OR PREVENTION OF ANY SPECIFIC HEALTH PROBLEMS, DISEASES, OR INFECTIONS, INCLUDING COVID-19. USERS OF THE CLIP DESIGN AND ITEMS DESCRIBED THEREIN ARE RESPONSIBLE FOR DETERMINING THE APPROPRIATE CIRCUMSTANCES, IF ANY, FOR THEIR USE OR FOR PROVIDING THEM TO OTHERS FOR USE. IN NO EVENT SHALL DEERE BE LIABLE FOR ANY DIRECT, INDIRECT, INCIDENTAL, SPECIAL, EXEMPLARY, OR CONSEQUENTIAL DAMAGES HOWEVER CAUSED AND ON ANY THEORY OF LIABILITY, WHETHER IN CONTRACT, STRICT LIABILITY, OR TORT (INCLUDING NEGLIGENCE OR OTHERWISE) ARISING IN ANY WAY OUT OF THE USE OF THE CLIP DESIGN, EVEN IF ADVISED OF THE POSSIBILITY OF SUCH DAMAGE. YOU SHALL HOLD HARMLESS AND INDEMNIFY DEERE AGAINST ANY AND ALL CLAIMS BROUGHT AGAINST DEERE ARISING FROM YOUR USE OF THE CLIP DESIGN AND ITEMS DESCRIBED THEREIN.

IP LICENSE: DEERE HEREBY GRANTS A LIMITED NON-EXCLUSIVE ROYALTY-FREE LICENSE TO INDIVIDUALS OR ORGANIZATIONS USING THE CLIP DESIGN TO AID IN THE RESPONSE TO COVID-19. THIS LICENSE DOES NOT INCLUDE ANY RIGHT TO USE ANY DEERE TRADEMARKS. DEERE RETAINS ALL RIGHTS AND PRIVILEGES AND MAY RETRACT THIS LIMITED NON-EXCLUSIVE LICENSE AT ANY TIME AND AT DEERE'S SOLE DISCRETION.

IMPORTANT SAFETY INFORMATION:

- NOT FOR PREVENTION OF DISEASE: The face shield clips are not intended to treat, protect from or prevent specific health problems, diseases, or infections, including respiratory diseases such as COVID 19.
- SINGLE-USE ONLY: The face shield clips are for single use only as they have not been designed to permit disinfection after initial use.
- INTENDED FOR KNOWLEDGEABLE USERS: Individuals or organizations that receive the face shield clips are responsible for using them in the appropriate circumstances, including satisfying any federal or state regulatory requirements that apply to medical selection and use of face shields or face shield clips, and are responsible for informing health care providers to which the clips are supplied that they are responsible for decisions regarding appropriate personal protective equipment for their personnel.

By downloading, copying, or using the Clip Design, you acknowledge and agree to these terms.

Deere & Company
April 2020

